

Neapolitan 80 (NP80G) Gas Fired Ovens



Overview

Our 80 Neapolitan Model, which is designed specifically to accommodate the high-volume pizza making of a true Pizzaiolo. The 80 features a 31.49 inch deck. The dome and deck consist of refractory bricks with 4 inches of multi-layered insulation in the dome and 8 inches in the deck. The oven features a 18 inch by 9 inch opening along with a stainless steel flue collar atop the dome.

The oven requires a 2" tolerance in all directions, and comes standard with a fire-rated tile clay dome. The 80 Neapolitan model also features a 14 inch landing on the opening, as well as a control located between the deck and the top of the dome for getting a precise reading. Oven can be vented directly to the roof or vented through a powered type 1 exhaust hood with approved exhaust duct in accordance with all local and national codes. For wood burning ovens, they must be vented as a solid fuel burning appliance and must be installed following a manner that obeys all local and national codes and is acceptable to authority having jurisdiction.

Pizza Capacity

Cooking Surface = 6.9 sq. ft.
Pizza Capacity 8" = 4-5
Pizza Capacity 10" = 3-4
Pizza Capacity 12" = 2-3
Pizza Capacity 16" = 1-2

Gas Requirements

Gas connections 3/4" NPT per burner,
quick disconnect gas hose must be used.
Pressure required 10" - 14" W.C. (Water
Column) at the gas valve.
84,000 BTU's per burner.

Electric Requirements

120V/ Single Phase / 12 Amps
9 ft. power cable integrated.

Venting

The oven is vented through an 6" round duct collar. The Neapolitan gas ovens can be installed with a listed exhaust hood system or with a direct vent exhaust duct vented outside without an exhaust hood, but must be installed with a power exhausted vent. Cubic Feet per Minute: 150CFM
Static Pressure: 0.01" W.C.

Standard Features

Standard Tile Selection
Door
Proprietary Refractory Brick Deck
Turbo Burner
High Temperature Flue Collar/Adapter
Steel Stand
Black Powder Coating
3 Year Deck and Dome Warranty
1 Year Parts and Labor Warranty

Optional Features

Tile Upgrade/Customized Logo
Custom High-temp Vinyl Decal
Custom Tile Applications
Plug & Play Ventilation
Powered Exhaust Fan
Stainless Steel Mask/Stand
Enclosed Facade
Double Mouth Opening
All Fuel Grease Duct
Interior Lights
Stainless Steel Oven Tools

Clearance Requirements

2" Minimum clearance for Combustibles on all sides.
0" Minimum clearance for Non Combustibles.

Shipping Dimensions

Actual Weight: 1700 LBS
Crated Weight: 2000 LBS
Crated Width: 73"
Crated Depth: 63"
Crated Height: 87"

Approved



Neapolitan 80 (NP80G) Gas Fired Ovens

Top View

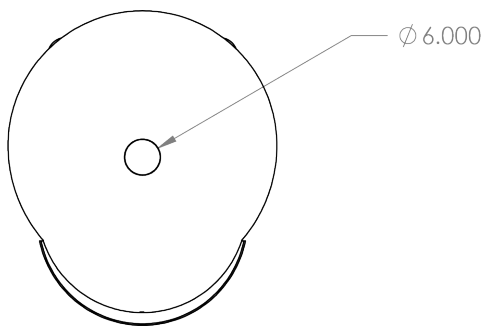

Plan View

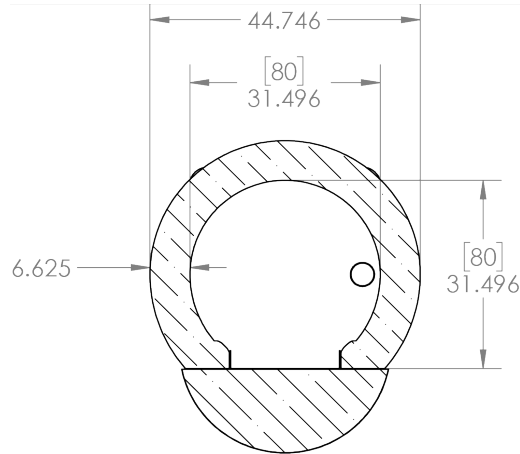

Front View

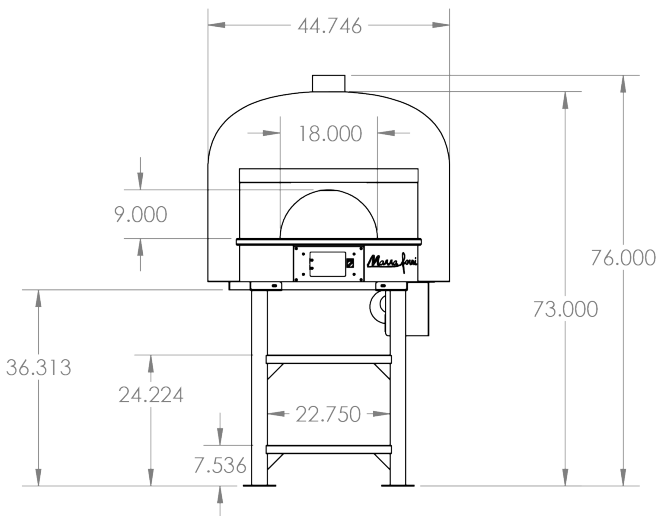

Side View

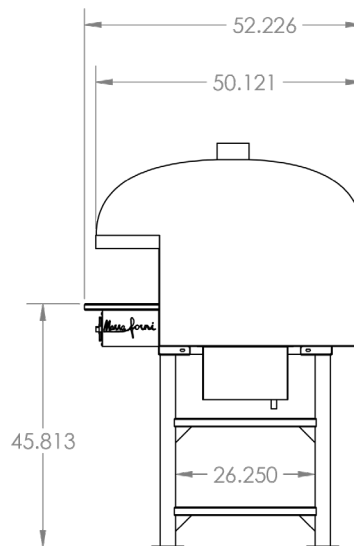

Legend

- C**-Controls
- E**-Electrical Connection Flexible Cord
- F**-Flue Collar
- G**-Gas Connection
- S**-Storage Shelf

Notes

An ongoing program of product improvement may require us to change specifications without notice.

All ovens are designed to suit commercial usage.

Spec dimensions to be +/- 0.50 inch.

Oven sizes refer to dome interior size.

All Marra Forni ovens are ETL, and VPN approved.

All oven Freight Class 77.5 and must be shipped LTL.

Learn about gas, electrical, venting and clearance requirements at MARRAFORNI.COM

